



intelliGen Field Mount (iFM) Kit

H-IM-iFM

July 2023

Part No. 25011801

Installation and Operation Manual



Table of Contents

- intelliGen Field Mount (iFM) Kits 2
- Components needed for Installation 2
- Preparation for Installation 3
- Components Included in Kit.....4-7
- Components Not Included in Kit 8
- Electronic Expansion Valve EXV8-9
- Field Wire Connections..... 10
- Unit Cooler Product Families Supported..... 11
- Main Control Board (iRC) Layout..... 12
- User Interface (iRCUI) Layout..... 13
- Optional Remote Access Cards..... 13
- Typical Wiring Diagrams..... 14-15
- Remote Mount intelliGen Controller 16-17
- Components Installation in Unit Cooler 18-21
- Retrofit of an Existing Unit Cooler 22
- Check-Out Installation..... 23
- System Start Ups 24-25
- iFM Kit Accessories 26



Scan QR code to view the manual online



intelliGen Field Mount (iFM) Kits for Unit Coolers

The intelliGen™ Field Mount Kit is designed to install in the field for new unit coolers without factory mounted controls or retrofit of existing unit coolers with mechanical control to upgrade to electronic control. The intelliGen control can be remote mounted up to 40 feet from the unit cooler at a convenient location for easy access. The intelliGen control is pre-assembled in a IP65 rated housing for both indoor and

outdoor applications. It supports Heatcraft's major unit cooler product lines such as the Low Profile, Center Mount and Low Velocity Center Mount, Medium Profile, High Profile Large Unit Coolers and others. It is universal fit for field mount and retrofit for all air and electric defrost unit coolers for refrigeration.

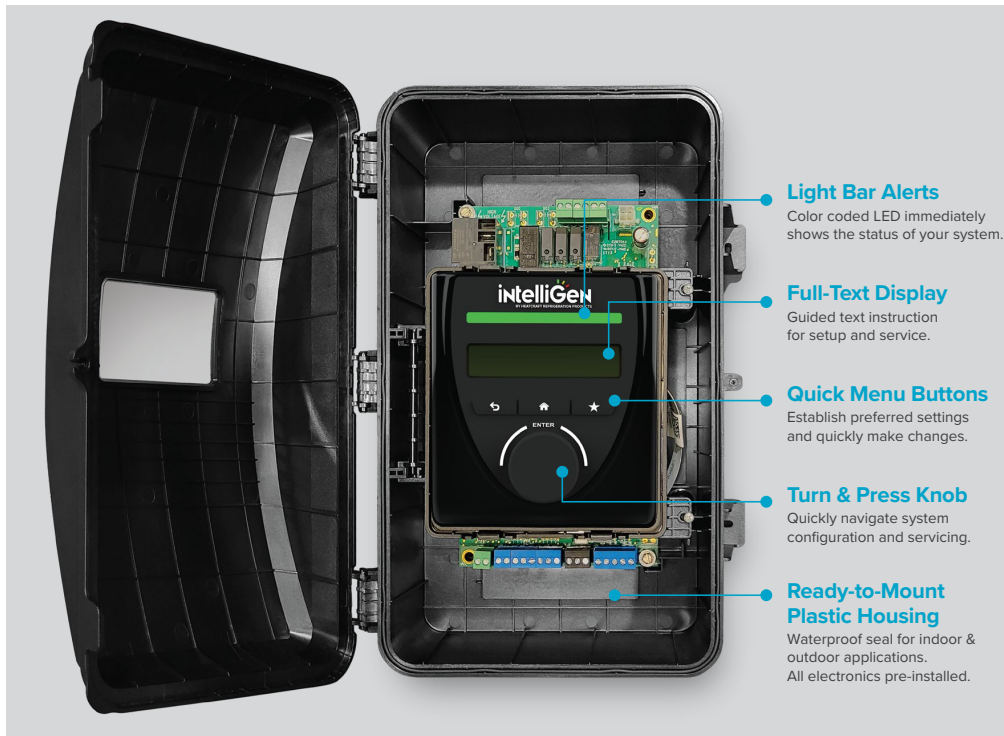

Components Needed for Installation

The iFM kit comes with the intelliGen controller, 3 temperature sensors, 1 pressure transducer with cable, 1 terminal board and mounting accessories. The temperature sensors and pressure transducer cable are 25 feet in length. Other wire lengths are available as optional kit in separate part numbers. **See Components Included section for details.**













There are individual **system dependent components are not included but required** for each installation. These components include the 24VAC control power transformer, the electronic expansion valve (EXV), the power wires for control power, fan motors, defrost heaters and solenoid





valve. Not all applications require defrost heaters and solenoid valve, check the system requirement for wiring needs.

See Components NOT Included section for details and availability options.

Field wire runs between the intelliGen controller and the unit cooler should be in conduits and have to meet local building and electric code requirements. Conduit fittings are needed for the conduit runs. Please conduct a site survey and review your local codes for detailed requirements prior to installation. Low voltage and communication wires need to run in separate conduit from the high voltage wires to minimize interference.

Preparation for Installation

Needed Tools			
Tools	Description	Tools	Description
	Slotted Screwdriver		Wrench, 7/16" and 5/8"
	Phillips Screwdriver		Adjustable Wrench
	Precision Slotted Screwdriver		Wire Stripper/ Crimper
	5/16" Nut Driver		5/32" Hex (Allen) Key
	Power Drill & Drill Bits		Wire Puller (Fish Tape)
	Hacksaw		Brazing Tools

Tools Might Be Needed			
Tools	Description	Tools	Description
	Wire Marker Label		Electrical Tape
	Multimeter		Marker

Components Included in the Kit

- **intelliGen Controller** - Quantity of 1



Main control board and user interface board are pre-assembled in a IP65 rated housing.

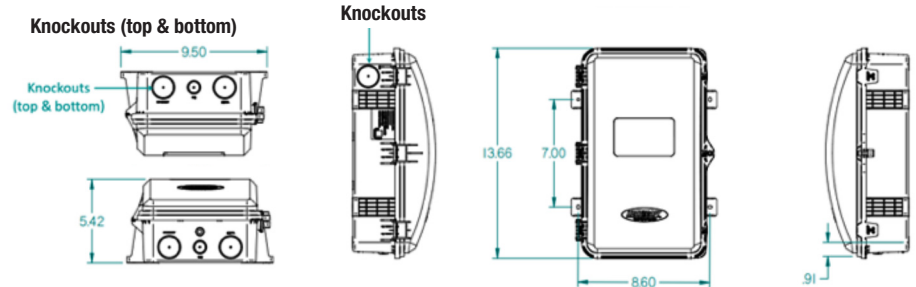

- **Temperature Sensors** - Quantity of 3



For room temperature, suction temperature and coil temperature (25 feet length)

- **Pressure Transducer Harness** - Quantity of 1



For suction pressure transducer connection (25 feet length)

- **Terminal Board** - Quantity of 1



For power, fan motors and defrost heater wire connections

Temperature Sensor Brackets & Accessories Bag

- **Room Temperature Sensor Bracket** - Quantity of 1

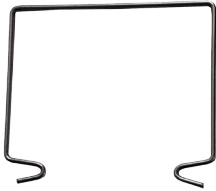

For mounting the room temperature sensor at the return air side of the unit cooler.

- **Suction Temperature Sensor Tube** - Quantity of 1



For mounting the suction temperature sensor to the suction refrigeration line.

- **Coil Temperature Sensor Bracket** - Quantity of 1



For mounting the coil temperature sensor to the coil.

- **Mounting Screws** - Quantity of 4



Two screws for the coil temperature sensor mounting bracket. Two screws for the terminal board.

- **Cable Ties** - Quantity of 2



Cable ties for securing the room temperature sensor to the mounting bracket.

intelliGen Field Mount (iFM) Kits



Pressure Transducer & Accessories Bag

- 300 PSI Pressure Transducer - Quantity of 1



Mount on the main suction line port to measure suction pressure.

- Cork Tape Roll - Quantity of 1



Insulation tape for suction temperature sensor tube to prevent condensation

- Cable Ties - Quantity of 2



Cable ties for securing suction temperature sensor inside the metal tube and the suction line

- Wire Sheathing - Quantity of 4



Wrap wires inside the iFM kit housing for additional protection

- Caution Label - Quantity of 1



Caution label for suction temperature sensor installation

- Labels for User Interface Panel - Quantity of 1

intelliGen	
Company Name	
Contact Person	
Phone	
E-mail	
Date of Installation	

intelliGen	
Information labels to apply on user interface swinging panel	

Instruction Manuals Bag

- iFM Kit Quick Start Guide

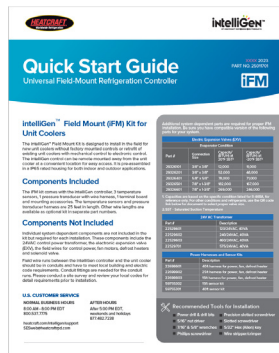

- intelliGen Installation and Operation Manual

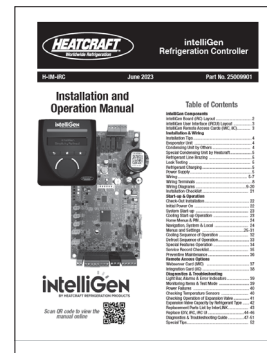



intelliGen Field Mount (iFM) Kits

Components NOT Included in the kit but are needed for installation

These are system dependent components based on application. **Field installer to provide these components separately based on the specific system requirement.**

- **24VAC Control Power Transformer** – quantity of 1
A 24VAC step down transformer from system voltages (120VAC, 208-230VAC, 460VAC or 575VAC) is needed to power the intelliGen control.

Heatcraft 24V AC Transformers	
PART #	Description
22529601	120/24VAC, 40VA
22529602	240/24VAC, 40VA
22529603	460/24VAC, 40VA
22529701	575/24VAC, 40VA

Note: For small unit coolers like Heatcraft's Low Profile Unit Coolers with 460VAC or 575VAC system voltages, external contactors are required to power the motors and heaters due to limited cabinet space to mount the components.

- **Electronic Expansion Valve EXV** -
Quantity of 1 (If use EXV is preferred)

These EXVs are available from Heatcraft. Field installer to select and provide one of these valves to match the system capacity requirement. A valve cable with the length matches the conduit run is also required.

PART NUMBER	R-22 Evaporator Temperature (°F) 100 psi Pressure Drop				R-404A/R-507 Evaporator Temperature (°F) 100 psi Pressure Drop			
	+20		-20		+20		-20	
	TONS	BTUH	TONS	BTUH	TONS	BTUH	TONS	BTUH
29326101	0.44	5220	0.41	4920	0.73	8706	0.64	7692
29326201	4.25	51000	3.99	47900	3.11	37309	2.75	32966
29326401	7.52	90260	7.54	90480	4.66	55964	4.12	49449
29326501	15.14	181680	14.25	171000	10.89	130692	9.62	115480
29326601	22.18	266160	20.87	250440	16.08	192985	14.21	170521

PART NUMBER	R-407A Evaporator Temperature (°F) 100 psi Pressure Drop				R-407C Evaporator Temperature (°F) 100 psi Pressure Drop			
	+20		-20		+20		-20	
	TONS	BTUH	TONS	BTUH	TONS	BTUH	TONS	BTUH
29326101	0.99	11831	0.90	10808	1.07	12898	0.99	11863
29326201	4.23	50704	3.86	46320	4.61	55279	4.24	50839
29326401	6.34	76056	5.79	69481	6.91	82919	6.35	76258
29326501	14.80	177616	13.52	162259	16.14	193641	14.84	178088
29326601	21.86	262273	19.97	239598	23.83	285938	21.91	262970

intelliGen Field Mount (iFM) Kits



PART NUMBER	R-407F Evaporator Temperature (°F) 100 psi Pressure Drop				R-448A Evaporator Temperature (°F) 100 psi Pressure Drop			
	+20		-20		+20		-20	
	TONS	BTUH	TONS	BTUH	TONS	BTUH	TONS	BTUH
29326101	1.09	13067	1.01	12094	1.01	12128	0.92	11098
29326201	4.67	56001	4.32	51831	4.33	51977	3.96	47561
29326401	7.00	84001	6.48	77746	6.50	77966	5.95	71341
29326501	16.35	196168	15.13	181562	15.17	182075	13.88	166604
29326601	24.14	289669	22.34	268100	22.40	268859	20.50	246014

PART NUMBER	R-449A Evaporator Temperature (°F) 100 psi Pressure Drop			
	+20		-20	
	TONS	BTUH	TONS	BTUH
29326101	1.01	12125	0.92	11083
29326201	4.33	51965	3.96	47499
29326401	6.50	77947	5.94	71249
29326501	15.17	182030	13.87	166389
29326601	22.40	268793	20.47	245696

Cables for Carel EXV	
PART NUMBER	DESCRIPTION
22592201	10ft cable for Carel EXV
22592102	25ft cable for Carel EXV
22592103	40ft cable for Carel EXV

Sporlan SER and SERI Series of Electronic Expansion Valve Support

The Sporlan SER and SERI Series of electronic expansion valves are supported. This valve option is selectable in the intelliGen Quick Start initial setup process. See Sporlan's website and document for SER and SERI Series valve sizes and selection <https://solutions.parker.com/sporlanvirtualengineer>

Field Wire Connections

Power wires between system components and the intelliGen controller

The field wire connections are to be provided by the field installer. A 25 feet long power harness with connectors and terminals preassembled is available from Heatcraft for ease of installation. The part number is 22699902. It includes the power wires listed below.

- 24VAC power wires for intelliGen control – two 18 AWG wire with ¼” quick connect terminal on one end and ¼” piggyback quick connect terminal on the other end
- Fan motor wires – two 18 AWG wires with ¼” female quick connect terminals on both ends
- Defrost heater wires – two 14 AWG wires with fully insulated ¼” female quick connect terminals on both ends, and two 18 AWG wires with fully insulated ¼” female quick connect terminals on both ends. (Wires need depend on application.)
- Solenoid valve control wires – two 18 AWG wires with ¼” female quick connect terminals on one end and bare wires on the other end. (Wires need depend on application.)

Heatcraft Power Harnesses	
PART #	Description
22699903	15ft harness for power, fan, defrost heater
22699902	25ft harness for power, fan, defrost heater
22699901	40ft harness for power, fan, defrost heater

Note:

For systems with defrost heater load higher than 30 Amp, external contactors are required to power the defrost heaters. The defrost heaters relay on the intelliGen controller use as pilot relay for the external contactors.

Conduit runs for field wires

Field wires between the intelliGen controller and the unit cooler should be in conduits and meet local building and electric code requirements. Conduit fittings are also needed based on installation application. A site survey and installation planning is recommended to determine conduit lengths and the type of conduit fittings and quantity needed. It is required to run power wires and low voltage (sensors and communication) wires in separate conduits.

Wire Protection

High voltage and low voltages wires inside the iFM kit requires additional insulation protection. Wire sheathing should cover all wiring within the iFM enclosure. Sets of wire sheathing are provided with the iFM kit. High voltage wires may share a sheath, and low voltage wires may share a sheath, but each group should be separately sheathed to maintain separation.

intelliGen Field Mount (iFM) Kits



Unit Cooler Product Families Supported

The iFM Kit is designed to universal fit for Heatcraft's Unit Coolers and other manufacturer's Unit Coolers also.



Low Profile Unit Cooler



Center Mount Unit Cooler



Low Velocity Center Mount Unit Cooler

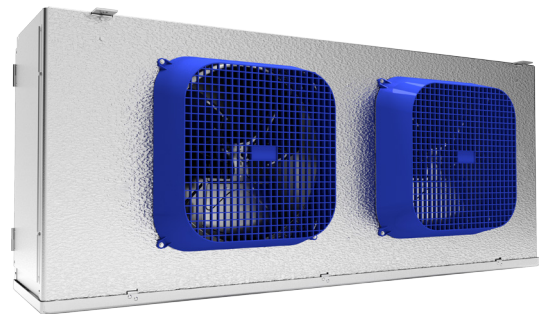

Medium Profile Unit Cooler



High Profile Large Unit Cooler

intelliGen Main Control Board (iRC) Layout

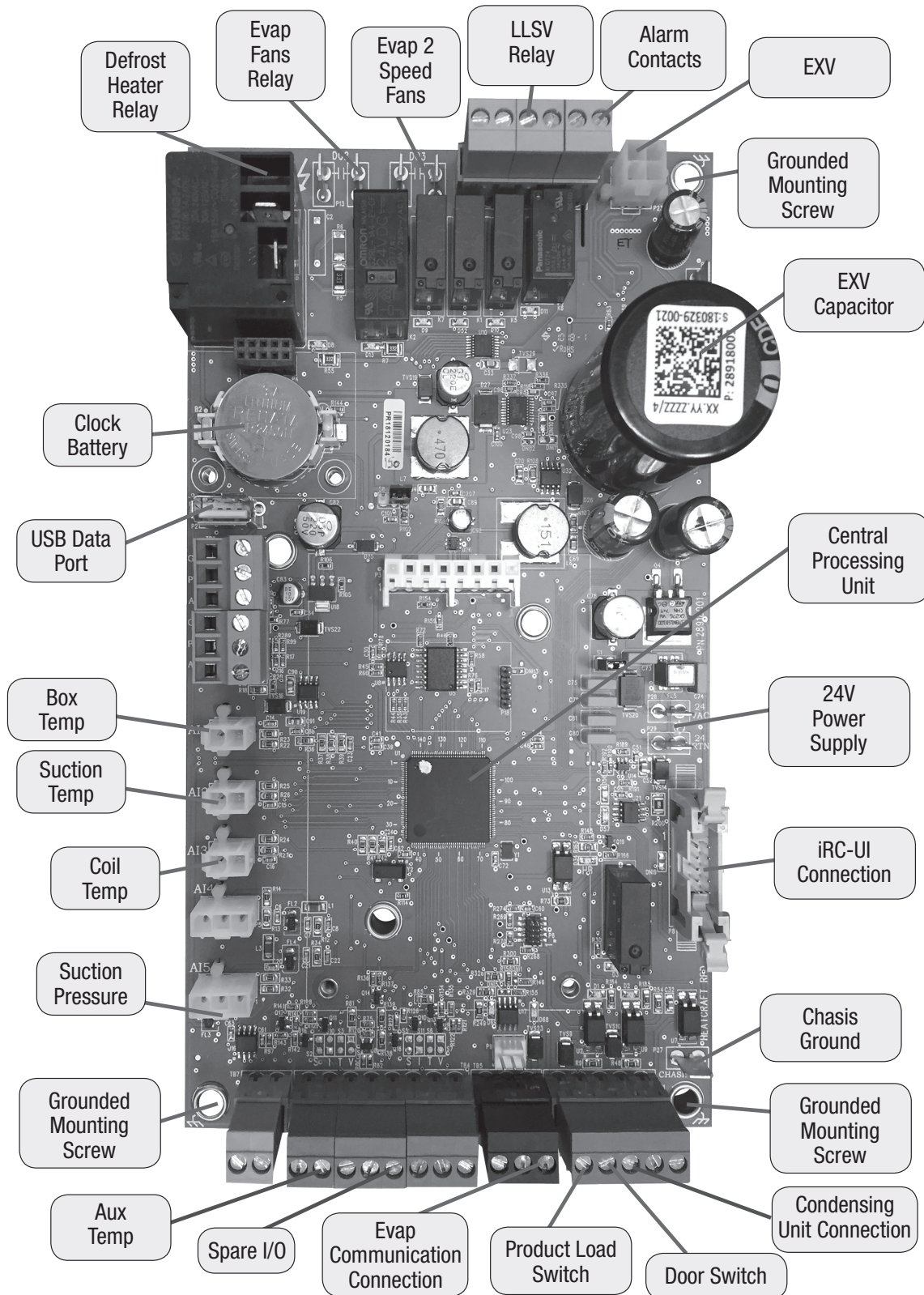

intelliGen Field Mount (iFM) Kits



intelliGen User Interface (iRCUI) Layout

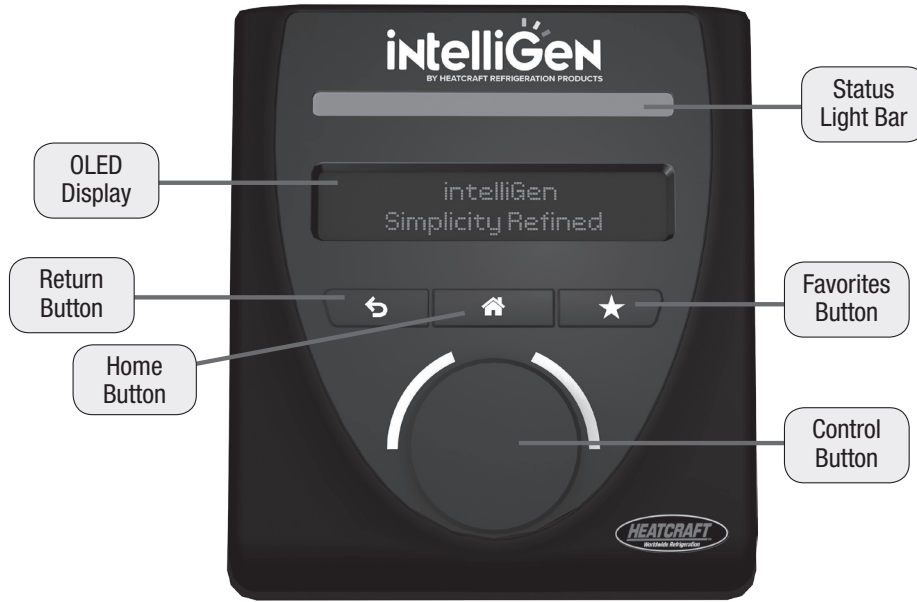

intelliGen Optional Remote Access Cards

MULTI-SYSTEM CONTROL CARD - MSC WEBSERVER CARD - iWC

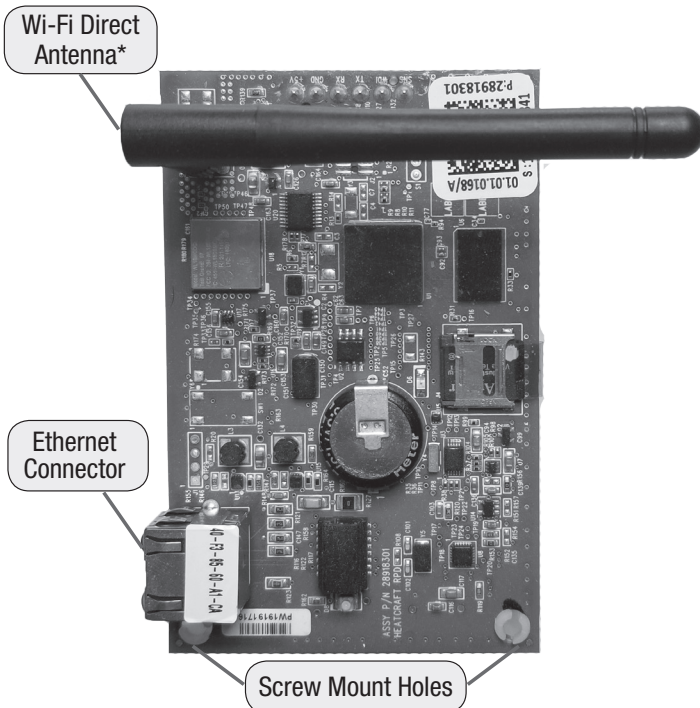

INTEGRATION CARD - iIC

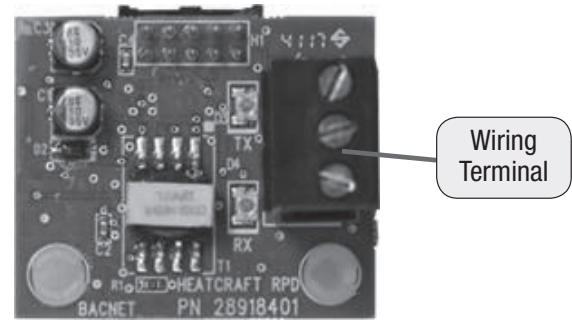

Scan QR code to view the manual or visit
www.intelliGencontrols.com/resources



LEGEND

Long Name	Abbrev. Name
Evap/Evaporator	EV
Set-Point	SP
Auxiliary	AUX
Temperature/Temp	TEMP
Calibration	CALIB
Electronic Expansion Valve	EXV
Condensing Unit	CU
Compressor	COMP
Connection	CXN
Lead-Lag	LL

NOTE: Refer to iWC & MSC Installation & Operation Manual (H-IM-iWC/MS) for installation and maintenance instructions.
* MSC card comes with Wi-Fi Direct antenna and the iWC webserver card does not come with Wi-Fi Direct antenna.

Typical Wiring Diagram For Applications With Contactors

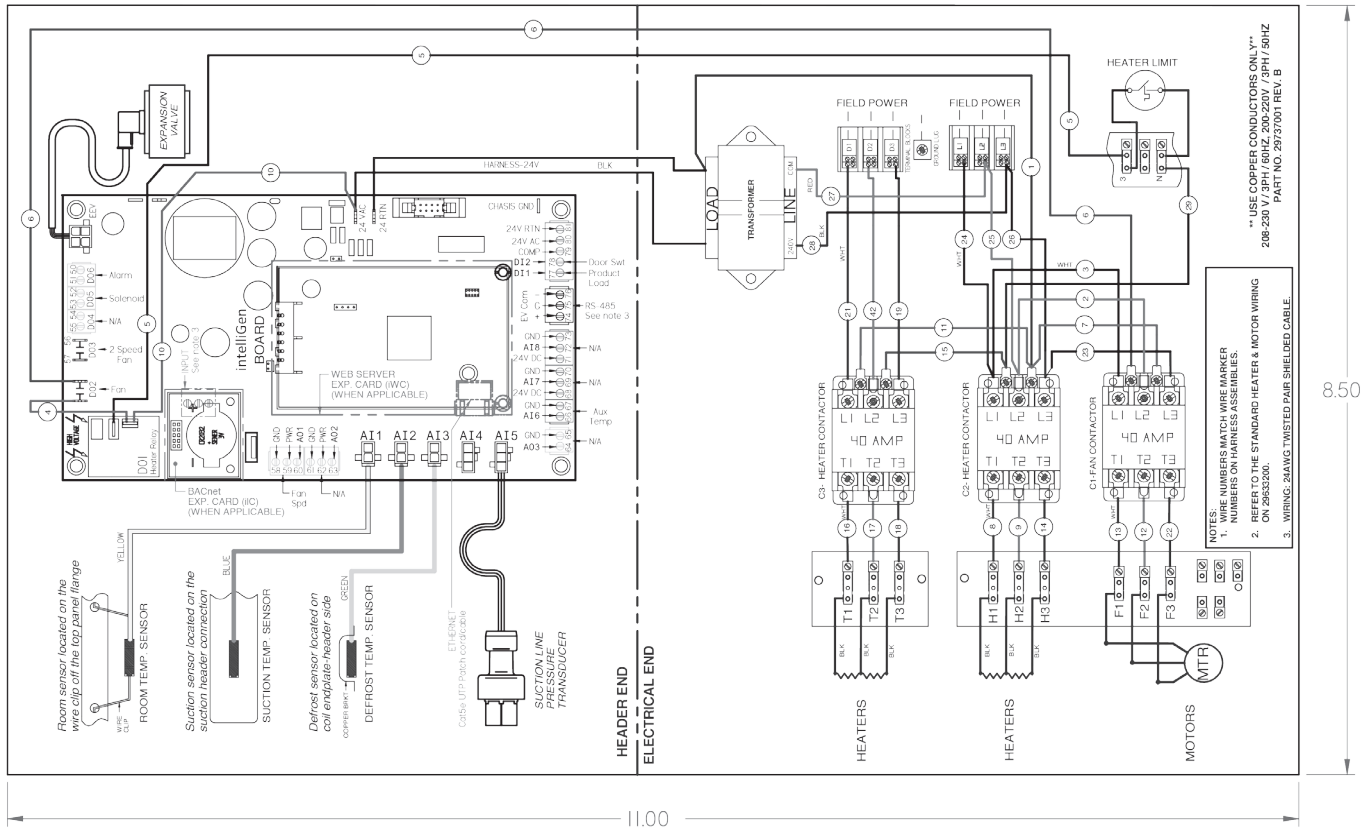

Typical Wiring Diagram For Applications Without Contactors

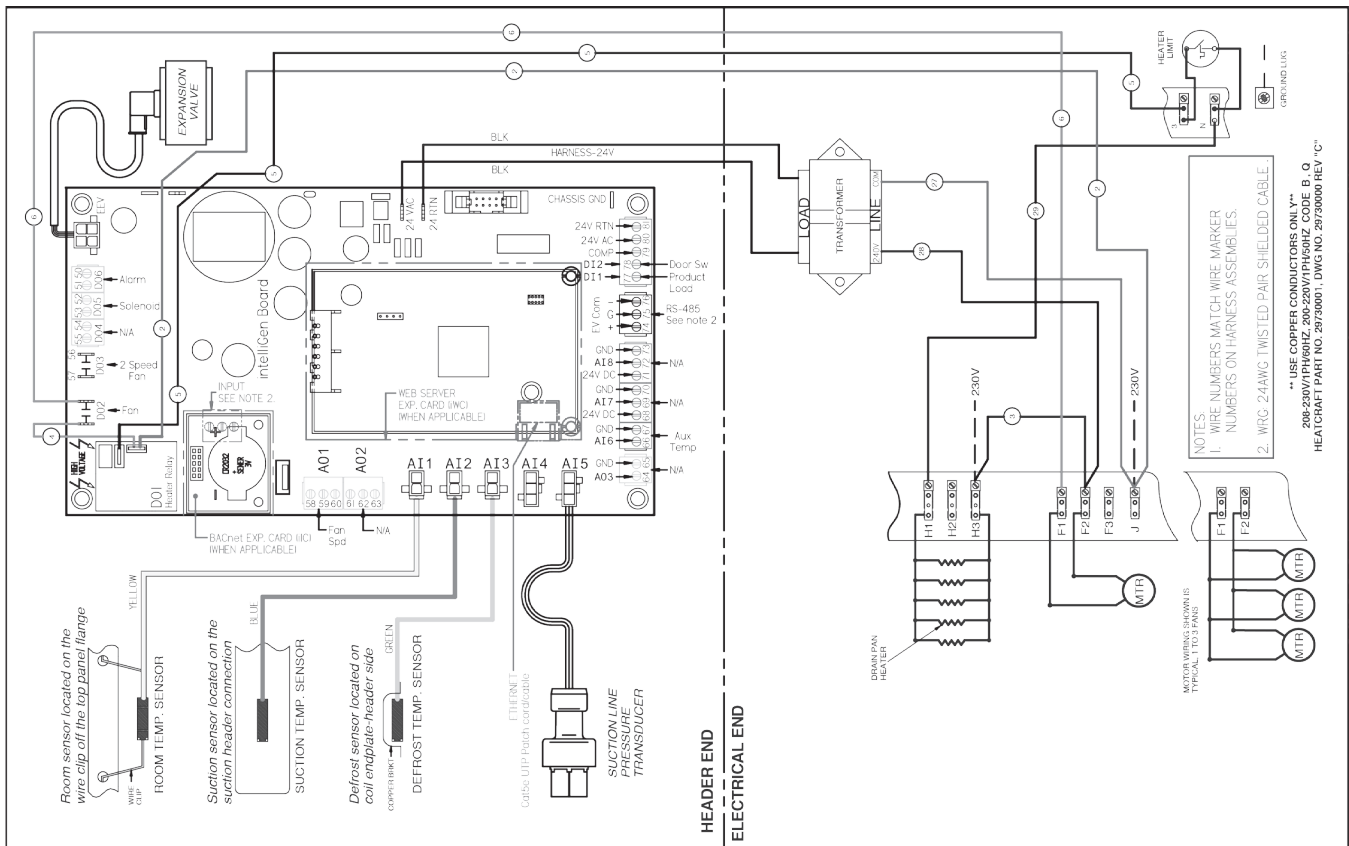

iFM Kit Installation Section



Typical Generic Condensing Unit Wiring Diagram for IntelliGen Stand-alone Evaporator Controller

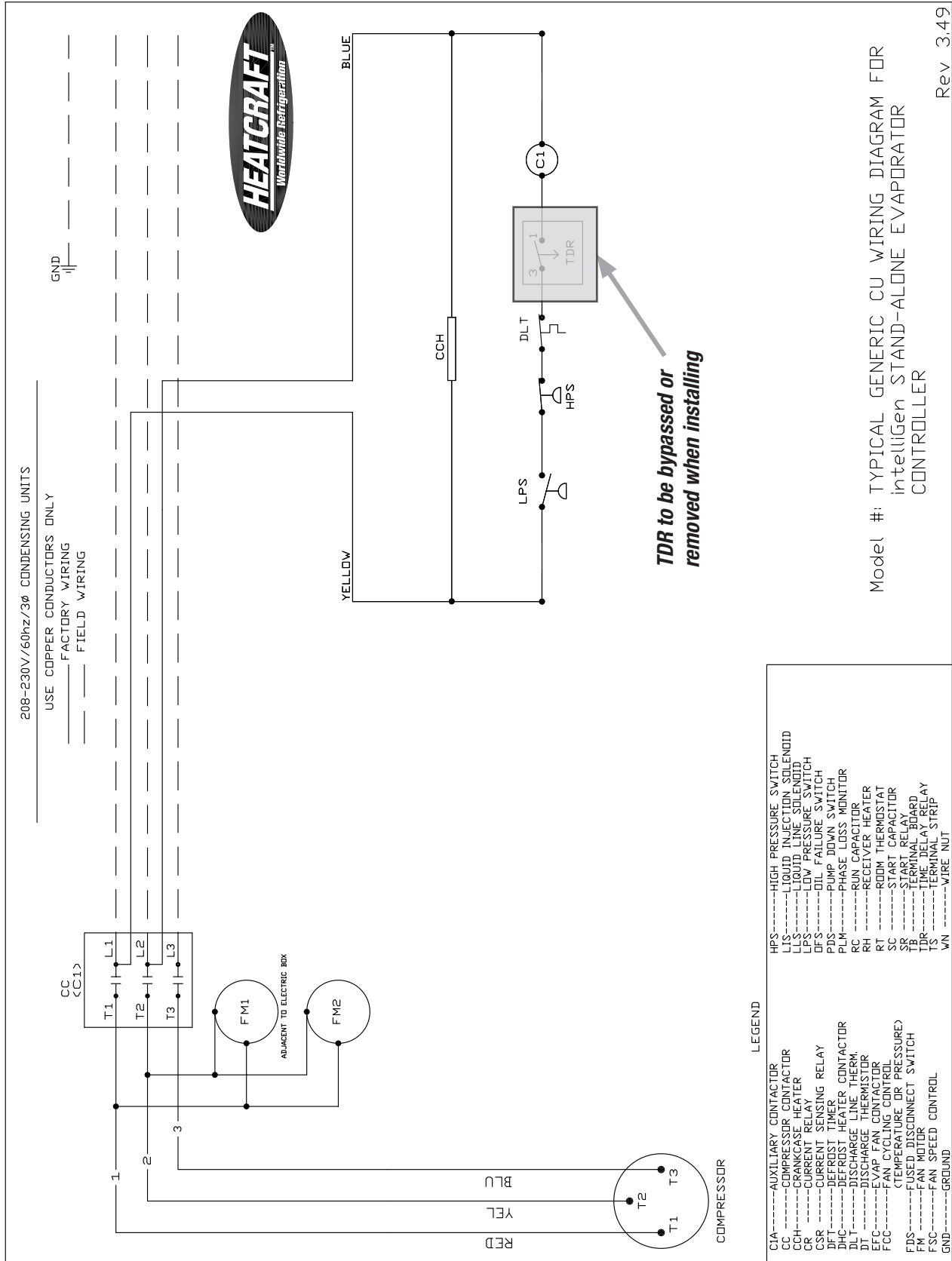

Remote Mount IntelliGen Controller

1. Identify Remote Mount Location

The iFM kit designed to be remote mounted up to 40 feet away from the unit cooler. The kit comes with 25 feet long wire sensors. A 40 feet long wire sensors kit is available separately. It can be mounted outside of a walk-in cooler, near the entrance door.

- a) Identify a flat surface to mount the iFM kit
- b) Prepare the mounting location and mark screw holes

Pro Tip: Use the iFM kit housing or the housing outline on the Quick Start Guide and mark the four screw holes

2. Route Conduits and Wires to Unit Cooler

- a) Determine length and conduit routing base on application need
- b) Determine the knockout on the iFM kit housing to use for conduit and wires routing. (1-1/2" and 7/8" knockouts are available at the top, bottom and the top left side of the housing.)
- c) Determine the conduit fittings for connecting the conduit to the iFM housing
- d) Run wires through the conduits
- e) Connect fittings to the conduits

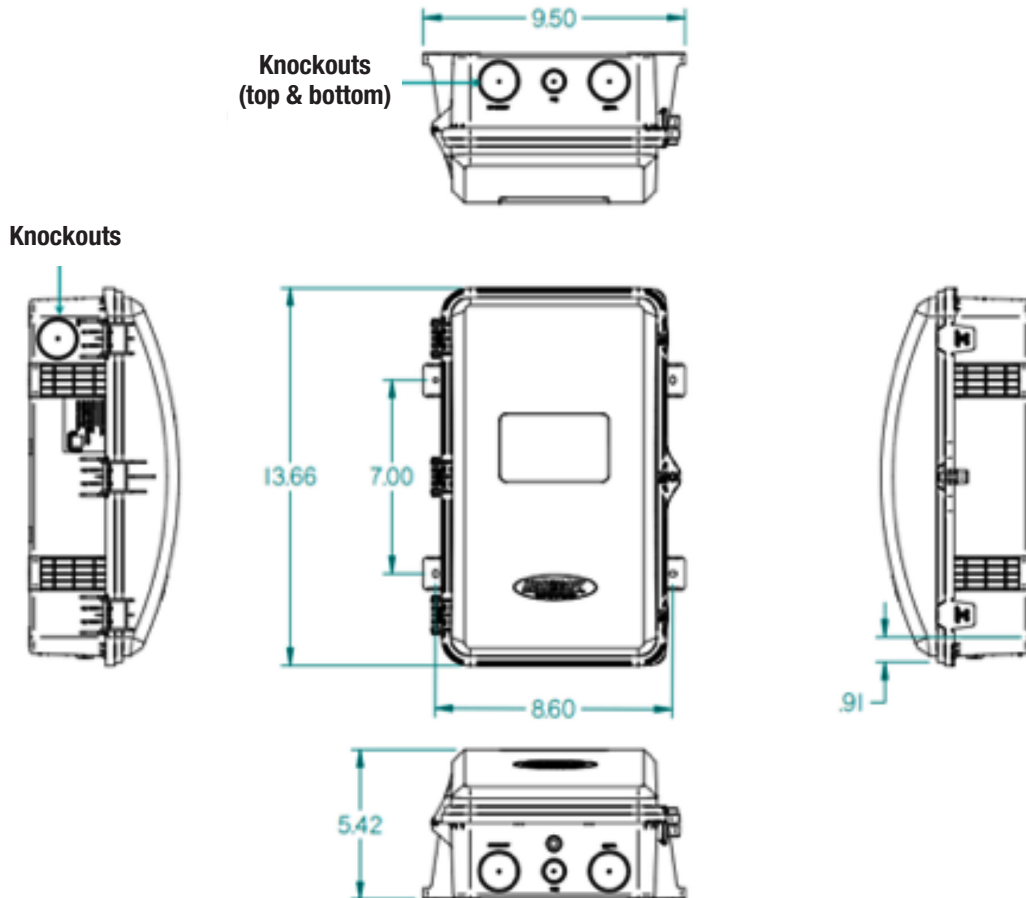

iFM Kit Assembly Dimensions (inch)

Pro Tip: Use knockouts on the left side or the top side for power wires and use the knockouts on the bottom for sensors and communication wires.

IntelliGen Board Layout



Remote Mount IntelliGen Controller (Cont.)

3. Mount the iFM Kit

- a) Mount the iFM kit housing to the marked screw hole locations with #10, 1-1/4" long screws
- b) Pull the wires through the knockouts on the iFM housing
- c) Tighten the conduit fittings to the conduit and to the iFM housing

4. Connect the wires to the IntelliGen control board

- a) Connect wires to the IRC main control board per the connections layout below.

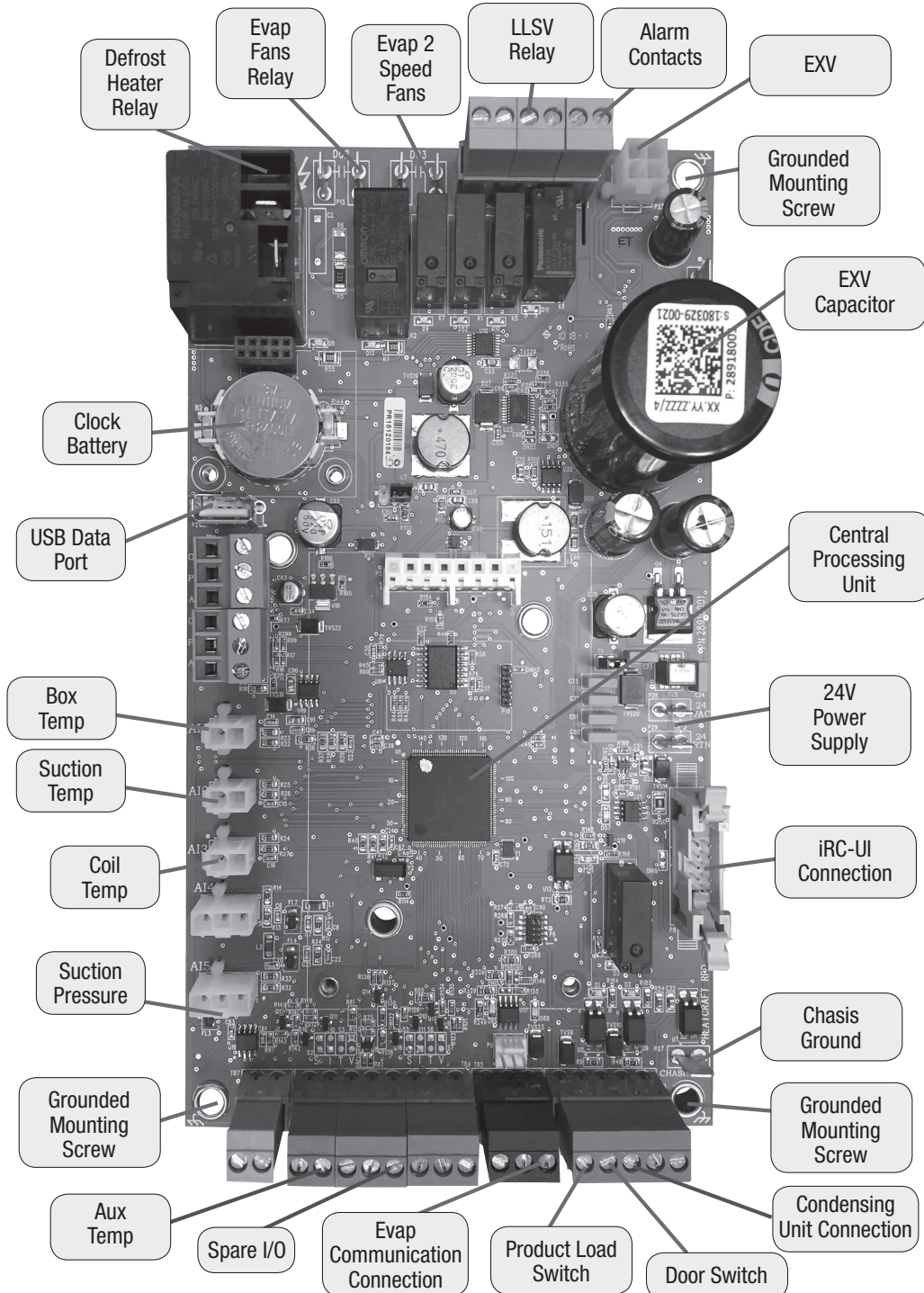

Components Installation in Unit Cooler

5. Power Transformer

- a) Select a 24VAC transformer with the primary voltage matches the system voltage
- b) Mount the transformer to the electrical end of the unit cooler, see picture shown as example

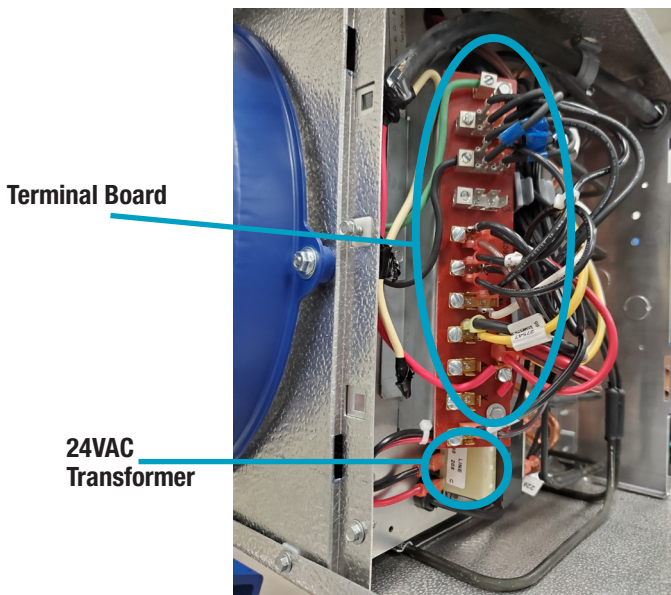

STEP 5 & 6

6. Terminal Board

- a) Mount the terminal board to the electrical end with the screws provided
- b) Connect the wires (transformer power, heater wires, motor fan wires, solenoid valve wires) as needed per the system requirement to the terminal board.

Pro Tip: Mount the new terminal board at the same location of the existing terminal board for incoming power

See wiring diagrams in the System Wiring Diagrams Section on Pages 14 and 15.

Components Installation in Unit Cooler (Cont.)

7. Temperature Sensors

- a) Room Temperature Sensor
 - i. Drill two ¼" holes, 1-1/4" apart, on the return air area of the unit cooler (typically at the back of the unit)
 - ii. Insert the Room Temperature Sensor Bracket into the two drilled holes as shown in the picture
 - iii. Use cable ties to secure the Room Temperature Sensor to the bracket as shown in the picture
- b) Suction Temperature Sensor
 - i. Braze the metal Suction Temperature Sensor Tube onto the suction line
 - ii. Insert the temperature sensor into the metal tube
 - iii. Wrap the temperature sensor and the metal tube with cork tape
 - iv. Secure the temperature sensor with the cable ties provided as shown in the picture
- c) Coil Temperature Sensor
 - i. Attached the Coil Temperature Sensor onto the Coil Temperature Sensor Bracket provided
 - ii. Screw tight the sensor bracket onto the coil end plate with the self-drilling screws provided. See picture as example

Room Temperature Sensor

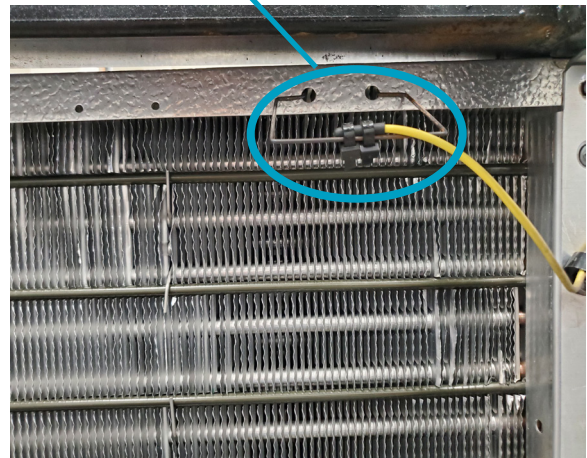

STEP 7a

Suction Temperature Sensor



STEP 7b

Coil Temperature Sensor

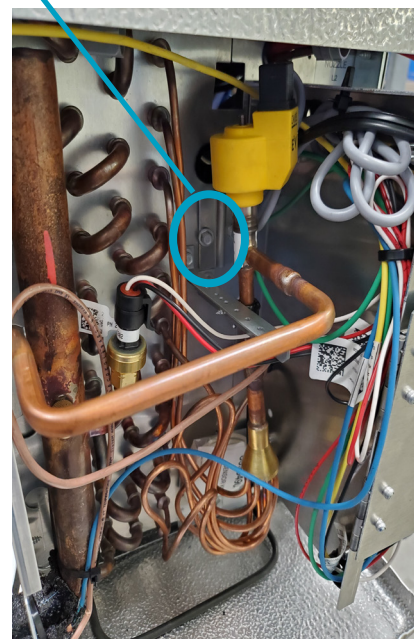

STEP 7c

Components Installation in Unit Cooler (Cont.)

8. Pressure Transducer

- a) Locate the Schrader valve on the suction line.
(Depends on system, a new Schrader valve may have to be installed or brazed onto the suction line.)
- b) Screw the pressure transducer onto the Schrader valve.

Pro Tip: Use correct tools to prevent damage to the Schrader valve and the copper pipe. Use 7/16" wrench to hold steady of the Schrader valve at the bottom, then tighten the pressure transducer at the top with a 5/8" wrench

- c) Plug in the pressure transducer harness and make sure the harness clip securely latches over the pressure transducer, see picture as example

Pressure Transducer

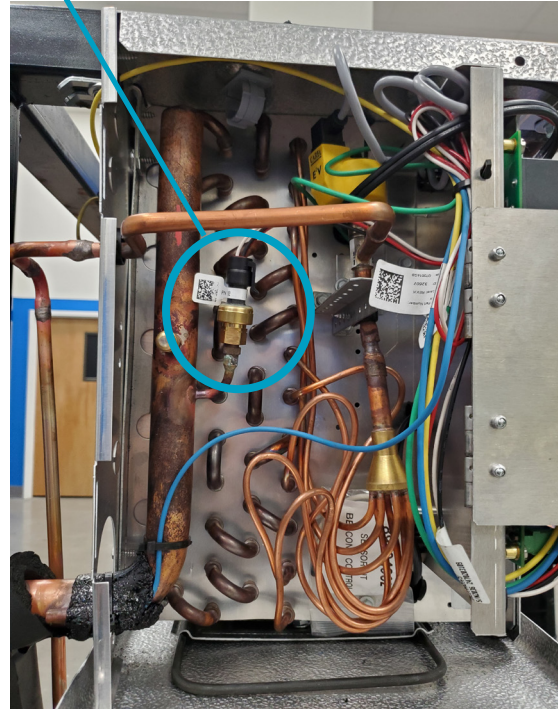

STEP 8

Components Installation in Unit Cooler

9. Electronic Expansion Valve (EXV)

- a) Select an EXV with capacity size that matches the unit cooler capacity
- b) Remove the EXV body from its motor/head
- c) Braze the EXV in place to the distributor connection and the liquid line stub to the EXV using proper brazing techniques
- d) Connect the wiring harness and the motor/head
 - i. Push the external motor stator assembly onto the top of the valve
 - ii. Tighten the mounting thumb nut to hold the motor in place on the top of the valve
 - iii. Smear a small amount of dielectric grease between the pins on the top of the motor. If dielectric grease is not available, automotive ignition grease can be used. (DO NOT use silicone.)
 - iv. Connect the wiring harness to the top of the motor/head assembly.
 - v. Now the valve had been successfully installed and ready for operation.

Pro Tip: Make sure the motor/head of the EXV is not pointing down. It should be pointed upward or horizontal.

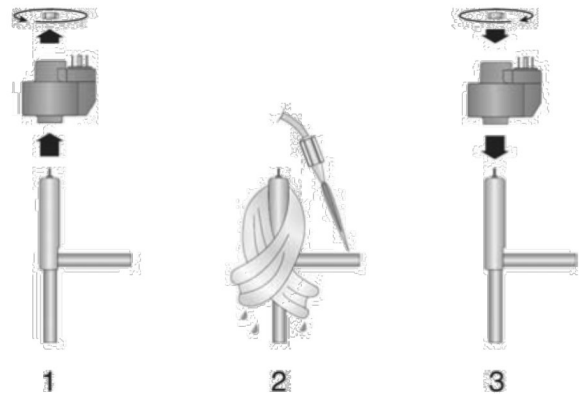

Pro Tip: This is to eliminate moisture presence between the pins and the control harness.

Electronic Expansion Valve (EXV)

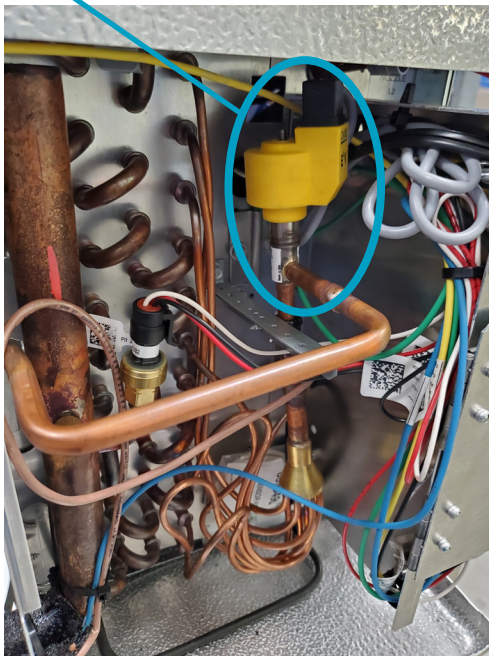

STEP 9

Pro Tip: The proper orientation of the harness plug is for the cable to run to the right as you are facing the Carel brand name on the motor/head. The plug has one wide slot that is to align with a wide spade connector on the motor/head.

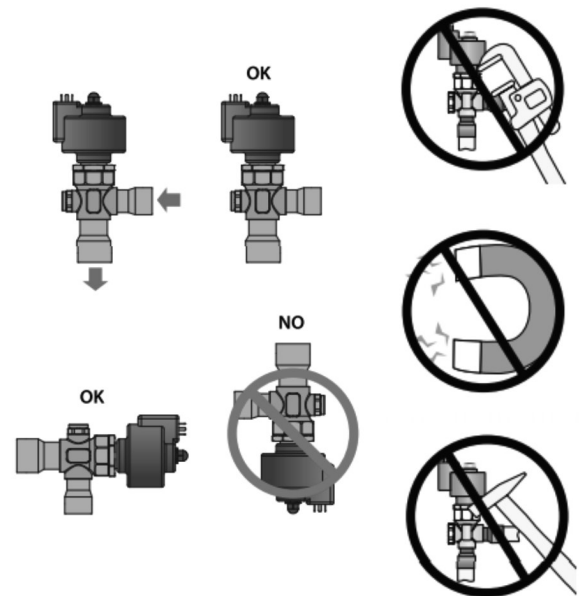

Do not exert torque or deforming stress on the valve or the connection pipes.

Do not hit the valve with hammers or other objects.

Do not use pliers or other tools that may deform the external structure or damage the internal parts.

Never aim the flame at the valve.

Never place the valve near magnetic fields.

Never install or use the valve in the event of:

- deformation or damage to the external structure;
- heavy impact, due for example to dropping;
- damage to the electrical parts (stator, contact carrier, connector,...)

Retrofit of An Existing Unit Cooler

Pump Down the Unit Cooler

1. Put the existing unit cooler into service mode and pump down the unit.
 - 1.1. Wait for the system to pump down and shut off. It could take up to 5 minutes.
2. Disconnect power to the unit cooler
3. Evacuate the system with proper refrigeration evacuation procedure (check I&O for unit coolers for additional steps)

Remote Mount IntelliGen Controller

1. See section Pages 16 and 17 for instructions of installing the remote mount IntelliGen controller

Components Installation in Unit Cooler

2. Disconnect wires and remove the existing terminal board in the electrical end of the unit cooler and replace with the new terminal board provided and a 24VAC transformer.
3. Remove the existing mechanical expansion valve (TXV) in the distributor end of the unit cooler and replace with a new electronic expansion valve (EXV)
 - a.) Cut and remove the TXV from the copper pipes.
4. See Pages 18 to 21 for instructions of installing new transformer, terminal board, temperature sensors, pressure transducer and EXV.
5. Wiring to solenoid valve (if needed by application)
 - f) Disconnect the existing wires terminated on the solenoid valve
 - g) Connect the two wires from the iFM controller to the solenoid valve

Terminal Board at Electrical End

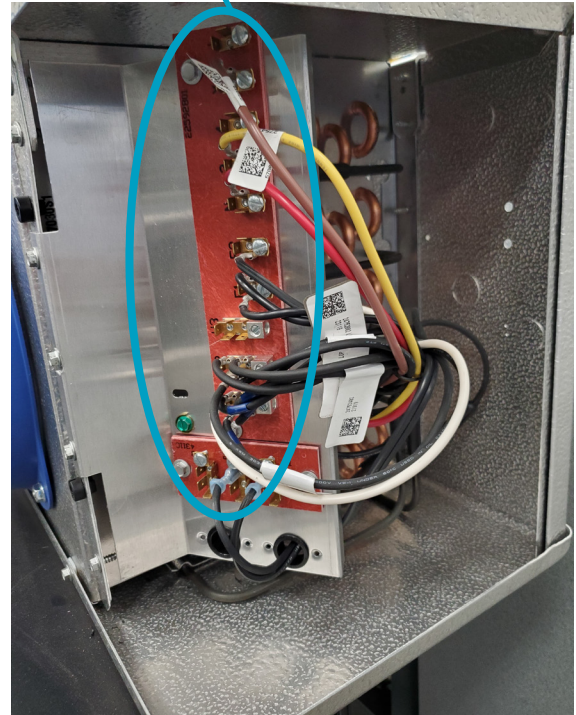

STEP 2 & 4

Thermal Expansion Valve (TXV)

Solenoid Valve

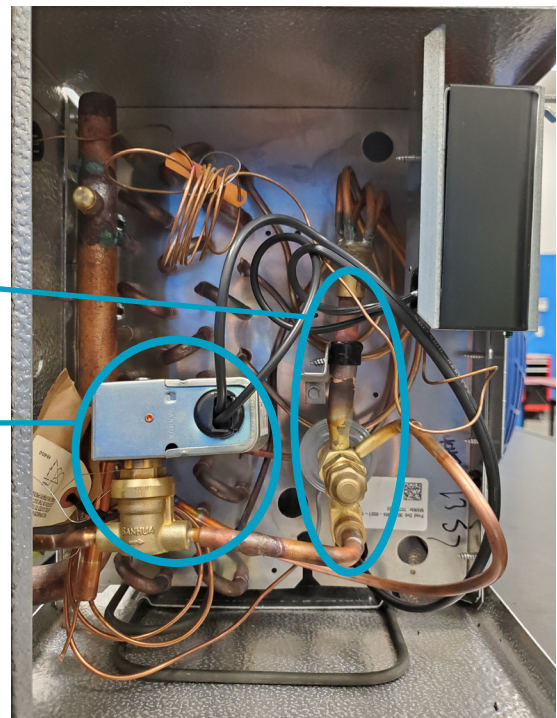

STEP 3 & 4

Check-Out Installation

After the installation has been completed, the following points should be covered before the system is placed in operation:

- (a) Check all electrical and refrigerant connections. Be sure they are all correct and tight.
- (b) Check voltage taps on transformer at the evaporators for proper supply voltage connection if a multi-tap transformer is used.
- (c) Check high and low pressure controls, pressure regulating valves, oil pressure safety controls, and all other safety controls and adjust them, if necessary.
- (d) On freezers only, check the low pressure switch setting. It must be set to 0 PSIG cut out, 10 PSIG cut in, to allow start and operation, especially in cold ambients. Applies to special IntelliGen condensing units only.
- (e) Suction and liquid lines should always be insulated.
- (f) Wiring diagrams, instruction bulletins, etc. attached to the condensing units should be read and filed for future reference.

- (g) All fan motors on air cooled condensers, evaporators, etc. should be checked for proper rotation. Fan motor mounts should be carefully checked for tightness and proper alignment.
- (h) Observe system pressures during charging and initial operation. Do not add oil while the system is short of refrigerant unless oil level is dangerously low.
- (i) Continue charging until system has sufficient refrigerant for proper operation. Do not overcharge. Remember that bubbles in a sight glass may be caused by a restriction as well as a shortage of refrigerant.

CAUTION: *Extreme care must be taken in starting compressors for the first time after system charging. At this time, all of the oil and most of the refrigerant might be in the compressor creating a condition which could cause compressor damage due to slugging. Activating the crankcase heater for 24 hours prior to start-up is recommended. If no crankcase heater is present, then directing a 500 watt heat lamp or other safe heat source on the lower shell of the compressor for approximately thirty minutes will be beneficial in eliminating this condition which might never reoccur.*

Initial Power On

When power supply is connected to the iRC for the first time, a series of inputs is required to identify specific system parameters. Since there are no factory set-point defaults pre-setup, the Quick Set-up procedure is triggered to capture essential information about the system when the system is first energized. This also occurs when a new iRC board is installed on a single evaporator system.

Inputs for the Quick Set-up are made using the iRC user interface (UI) control. The Control Knob on the iRC UI is used to navigate through the required steps and to identify selections. Turning the knob will navigate through possible selections for that particular parameter. Pressing the Control Knob makes selections (similar to an Enter key on a PC).



System Start-up

When the system is initiated for the first time, the compressor and the electric defrost evaporator fans will be in a hold-off cycle and will not start unless the hold-off cycle is complete. The electric expansion valve (EXV) then opens to 50% and will begin its superheat control sequence. The compressor starts and will be in a "hold-on" cycle. (This is to minimize short-cycling of the system).

At initial start-up, the system may cycle off after a few minutes and display a low superheat error, then restart itself. This cycle may be repeated a few times. Do not shut the system off. Let the system run, as it may take a few cycles for the electric expansion valve to attain the correct setting for the set superheat.

Do not leave the unit unattended until the system has reached normal operating conditions with the box pulled down to design conditions and the oil charge has been properly adjusted to maintain the oil level at the center of the sight glass.

When the room thermostat setting is satisfied (which may take a considerable amount of time on "hot-box" pulldown), and if the compressor has run for a minimum time for the "hold-on" cycle, the EXV will close (shutting off the refrigerant flow to the evaporator), and the system will pumpdown and shut off. The evaporator fans will continue to run.

Call for Cooling Start-up Operation

When the box temperature sensor detects a rise of approximately half the box temperature differential, and the system has been off a minimum of the hold-off cycle time, the EXV will open to its last position, and the compressor will start. The EXV is then adjusted as necessary to obtain and maintain the superheat setting. During this time, the compressor will run for a minimum of the "hold-on" cycle time.

intelliGen System Start Up

1. Follow the intelliGen “QUICK START GUIDE” to start up the system
2. For remote access installation of the webserver card (iWC) the Multi-system Control Card (MSC) or the integration card (iIC)
 - 2.1. See the remote access section of the intelliGen Installation and Operation Manual
3. For diagnostics and troubleshooting of the intelliGen system, see Diagnostics & Troubleshooting Section of the intelliGen I&O manual
4. To find all intelliGen resources, including installation & operation manuals, technical bulletins, brochures, maintenance, troubleshooting information and more, simply scan the QR code or use the link below.
www.intelliGencontrols.com/resources



iFM Kit Accessories

Electric Expansion Valves (EXV)			
Evaporator Condition			
Liquid Temperature at 100°F, Pressure Drop at 100 PSI			
Part #	Connection Size	Capacity* (BTUH) at 20°F SST**	Capacity* (BTUH) at -20°F SST**
29326101	3/8"x3/8"	12,000	11,000
29326201	3/8"x3/8"	52,000	48,000
29326401	5/8"x5/8"	78,000	71,000
29326501	7/8"x1-3/8"	182,000	167,000
29326601	7/8"x1-3/8"	269,000	246,000

* Capacities are based on the specific condition listed for R-448A, for reference only. For other conditions and refrigerants, use the QR code link below to select the proper valve size.

** SST - Saturated Suction Temperature

24VAC Transformer	
Part #	Description
22529601	120/24VAC, 40VA
22529602	240/24VAC, 40VA
22529603	460/24VAC, 40VA
22529701	575/24VAC, 40VA

Power Harnesses and Sensor Kits	
Part #	Description
22699903	15ft harness for power, fan, defrost heater
22699902	25ft harness for power, fan, defrost heater
22699901	40ft harness for power, fan, defrost heater
59755302	15ft sensor kit
59755301	40ft sensor kit
22592201	10ft cable for Carel EXV
22592102	25ft cable for Carel EXV
22592103	40ft cable for Carel EXV
22515107	15ft wire harness for pressure transducer
22515105	40ft wire harness for pressure transducer

Notes:

Heatcraft Refrigeration Products, LLC
2175 West Park Place Blvd., Stone Mountain, GA 30087
www.heatcraftprd.com

Customer Service and Technical Support

Normal Business Hours – 8:00 AM – 8:00 PM EDT
(800) 321-1881

After Hours (after 5:00 PM EDT, weekends and holidays)
(877) 482-7238

Since product improvement is a continuing effort, we reserve the right to make changes in specifications without notice.

©2023 Heatcraft Refrigeration Products LLC

The name behind the brands you trust.™ 